

Armário Toq 1400

Toq 1400 2 Doors Cabinet

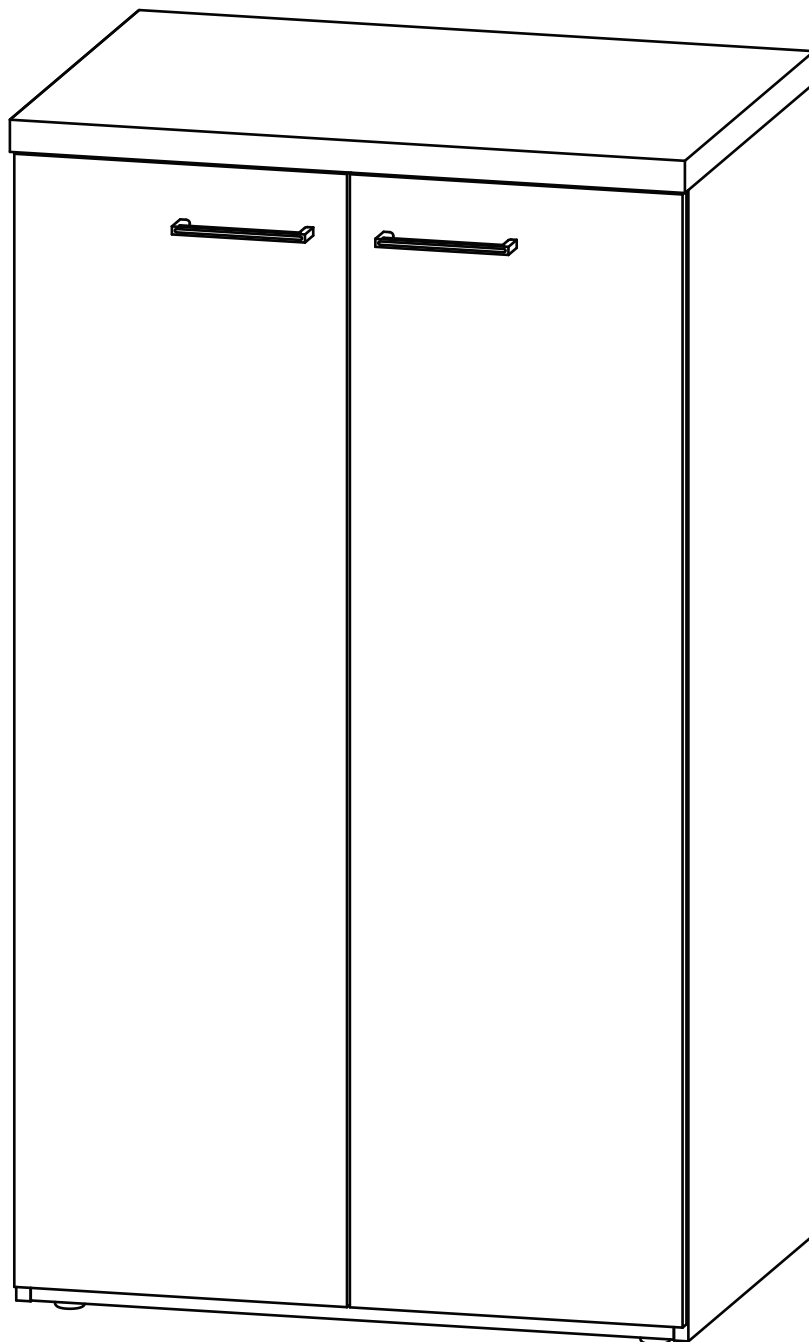

ARTANY[®]
Arte em Escritórios

Conheça outros produtos da nossa empresa no site: www.artany.com.br

Conozca otros productos en el sitio: www.artany.com.br

Know another products in: www.artany.com.br

- Siga atentamente todas as instruções de montagem;
- Monte seu produto no local ou próximo de onde será colocado. Movimentações do produto já montada, podem avariá-lo;
- Faça a montagem em uma superfície limpa e plana. Aconselhamos usar a própria embalagem de papelão para forrar o chão;
- Verifique se as quantidades de peças e acessórios estão de acordo com o manual de montagem;
- Compare atentamente os furos de cada peça com a ilustração do manual;
- Utilize as ferramentas indicadas. Só utilize parafusadeira se tiver conhecimento e habilidade. O uso inapropriado pode danificar peças e/ou acessórios;
- Se o produto necessitar fixação na parede, tenha cuidado para não atingir fios e canos ao furar a parede.

Obs: Caso necessite solicitar peças de reposição, por favor, utilize os códigos dos mesmos.

- Siga con atención todas las instrucciones de armado.
- Arme su mueble en un lugar cerca donde será instalado. Mover el producto ya montado puede perjudicarlo.
- Haga el montaje en una superficie limpia y plana. Aconsejamos usar el propio embalaje de cartón para forrar el suelo.
- Asegúrese de que las cantidades de piezas y accesorios coincidan con el manual de montaje.
- Compare cuidadosamente los agujeros de cada pieza con la ilustración del manual.
- Utilice las herramientas indicadas. Sólo utilice atornillador automático si tiene conocimiento y habilidad. El uso inapropiado puede dañar piezas y/o accesorios.
- Si el producto necesita fijación en la pared, tenga cuidado de no alcanzar cables y cañones al perforar la pared.

OBS: Si necesita solicitar piezas y / o accesorios de repuesto, por favor, utilice los códigos de los mismos.

- Follow carefully the assembly instructions.
- Assemble your furniture in a place near where it will be installed. Moving the assembled product can harm it.
- Make the assembly on a clean and flat surface. We recommend using the cardboard box to cover the floor.
- Make sure the quantities of parts and accessories match the assembly manual.
- Carefully compare the holes in each piece with the illustration in the manual.
- Use the indicated tools. Only use an automatic screwdriver if you have knowledge and skill. Improper use can damage parts and/or accessories.
- If the product needs fixing on the wall, be careful and don't reach cables and cannons when drilling the wall.

NOTE: If you need to request spare parts and/or accessories, please use the codes according of this instruction manual.

CONSERVAÇÃO E LIMPEZA

MANTENIMIENTO Y LIMPIEZA / MAINTENANCE AND CLEANING

Não expor o produto ao sol, altas temperaturas e umidade, mantendo-o em local seco e arejado. Para a limpeza, utilizar um pano seco e macio. Não é necessário o uso de materiais abrasivos ou álcool.

No exponga el producto al sol, altas temperaturas y la humedad. Mantener en local seco y ventilado. Para limpiar, utilice un paño suave y seco. No es necesario el uso de materiales abrasivos o alcohol.

Do not expose the product to sunlight, high temperatures and humidity. Keep it in a dry and ventilated place. To clean it, use a soft and dry cloth. It is not necessary to use abrasive materials or alcohol.

Garantia

Este certificado de Garantia é uma vantagem adicional oferecida ao consumidor, porém para que o mesmo tenha validade é imprescindível que seja apresentada a NOTA FISCAL de compra do produto e o número do lote (ver etiqueta).

Com este produto, a **Artany** tem como objetivo atender plenamente o proprietário-consumidor, proporcionando a garantia na forma aqui estabelecida, pelo período de 03 meses a partir da data da nota fiscal de compra. A **Artany** restringe a sua responsabilidade à substituição gratuita das peças defeituosas, em caso de defeitos ou avarias devidamente constatados como sendo de fabricação, durante a vigência desta garantia.

A **Artany** declara a garantia nula e sem efeito se o produto for alterado, adulterado, molhado ou consertado e ainda pela prática de montagem inadequada. Também será considerada nula em casos de força maior, como aqueles causados por agentes da Natureza (chuvas, incêndios, excesso de umidade...).

Para exercer seus direitos de comprador é importante que antes de montar seu produto você leia com atenção as instruções de cada passo do manual de montagem que acompanha o móvel.

Caso o produto não esteja em conformidade, entre em contato com a loja onde efetuou a compra ou com o nosso Serviço de Atendimento ao Cliente através do fone (41) 3556 1500 ou do e-mail assistencia@artany.com.br, e faça sua reclamação, apontando os defeitos técnicos observados, que teremos o maior prazer em atendê-lo. Para agilizar o seu atendimento, tenha sempre em mãos o manual de montagem com os respectivos números das peças defeituosas conforme descritas no manual.

FERRAMENTAS **NÃO** FORNECIDAS, MAS NECESSÁRIAS
PARA A MONTAGEM DO PRODUTO

HERRAMIENTAS **NO** SUMINISTRADAS, MAS NECESARIAS PARA EL MONTAJE DEL PRODUCTO
TOOLS **NOT** SUPPLIED, BUT NECESSARY FOR THE ASSEMBLY



100097

12X



100070

20X



100503

4X



100594

24X



102349

2X



100069

20X

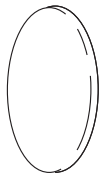

102958

16X

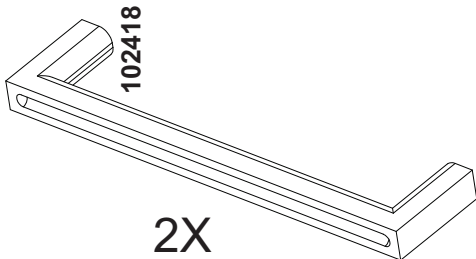

102418

2X

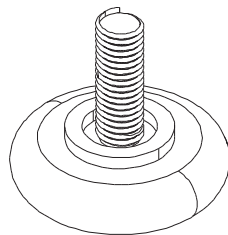

102614

4X

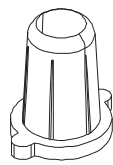

100560

4X

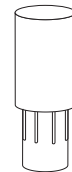

102433

8X

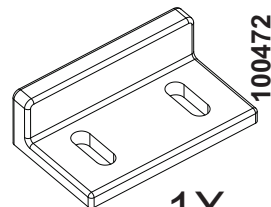

100472

1X

DOBRADEIRA - 104173

BISAGRA / HINGES

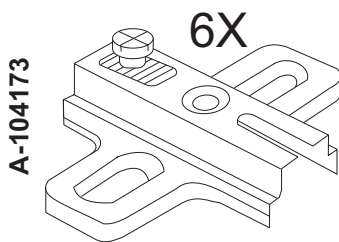

A-104173

6X

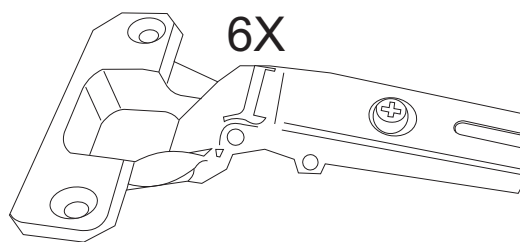

B-104173

6X

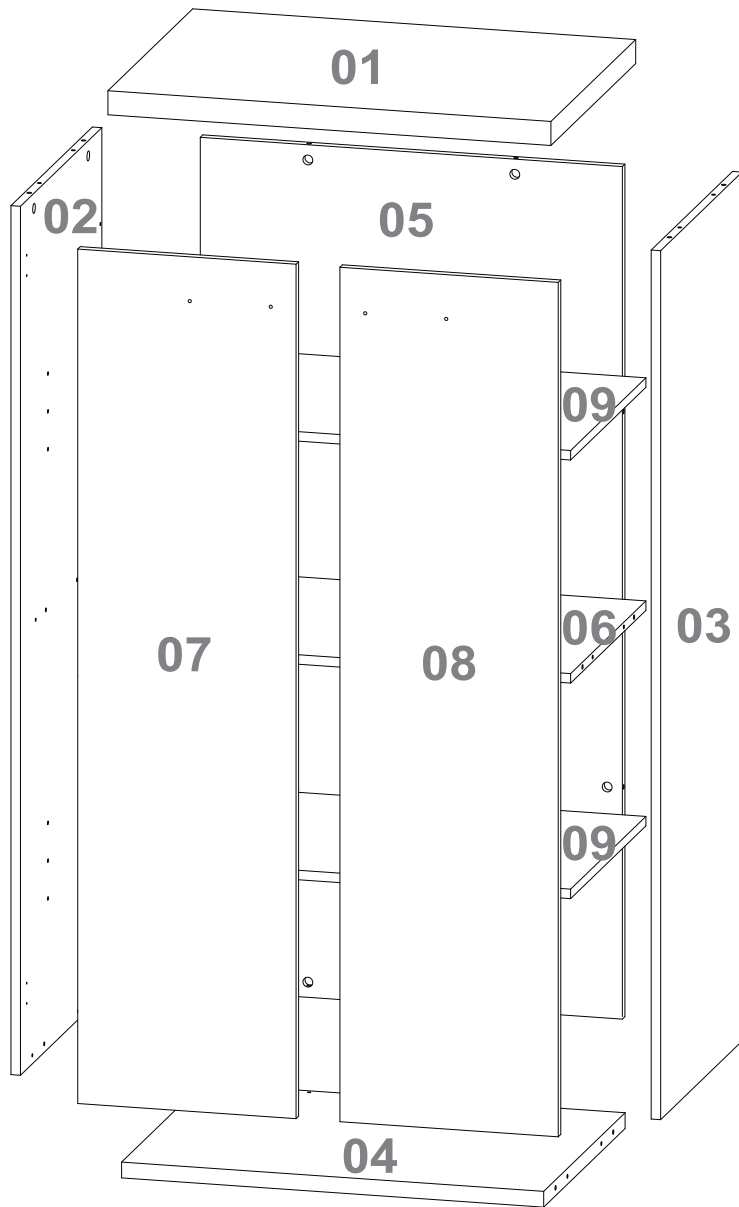

Número Número	Medida Dimensión Size	Quantidade Cantidad Quantity
01	700x500x37mm	01
02	1348x480x15mm	01
03	1348x480x15mm	01
04	667x480x25mm	01
05	1322x667x15mm	01
06	667x444x15mm	01
07	1325x345x15mm	01
08	1325x345x15mm	01
09	665x420x15mm	02

1

6X

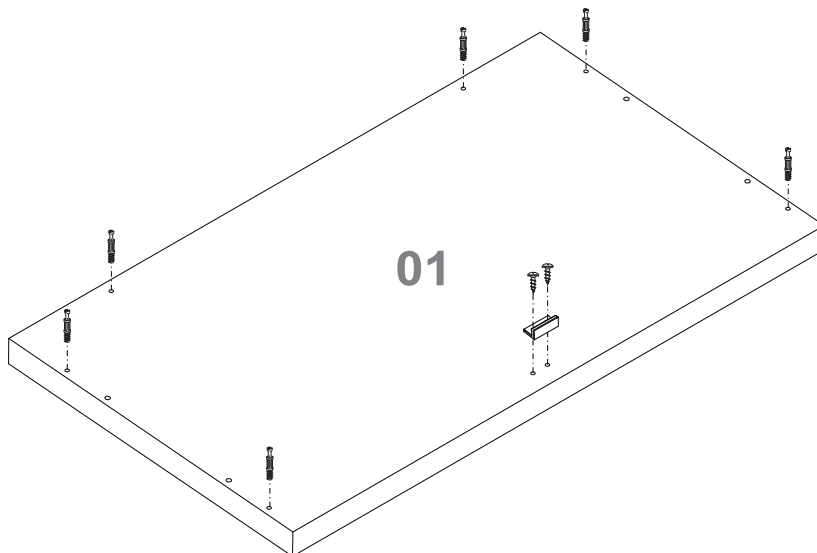

1X

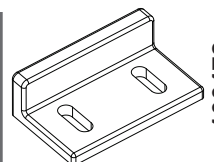

2X



2

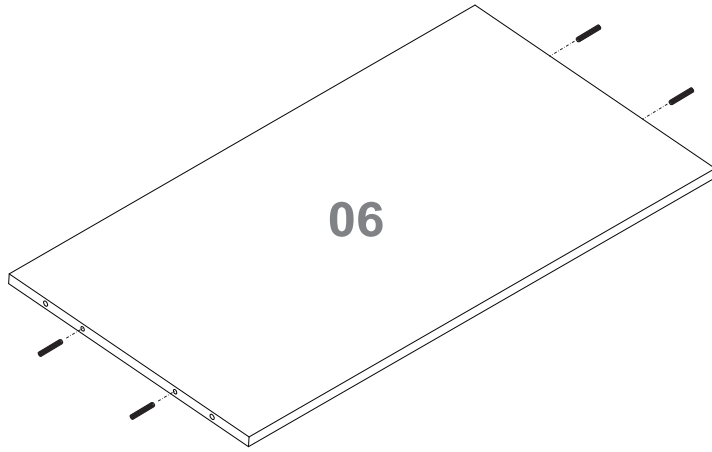

4X



3

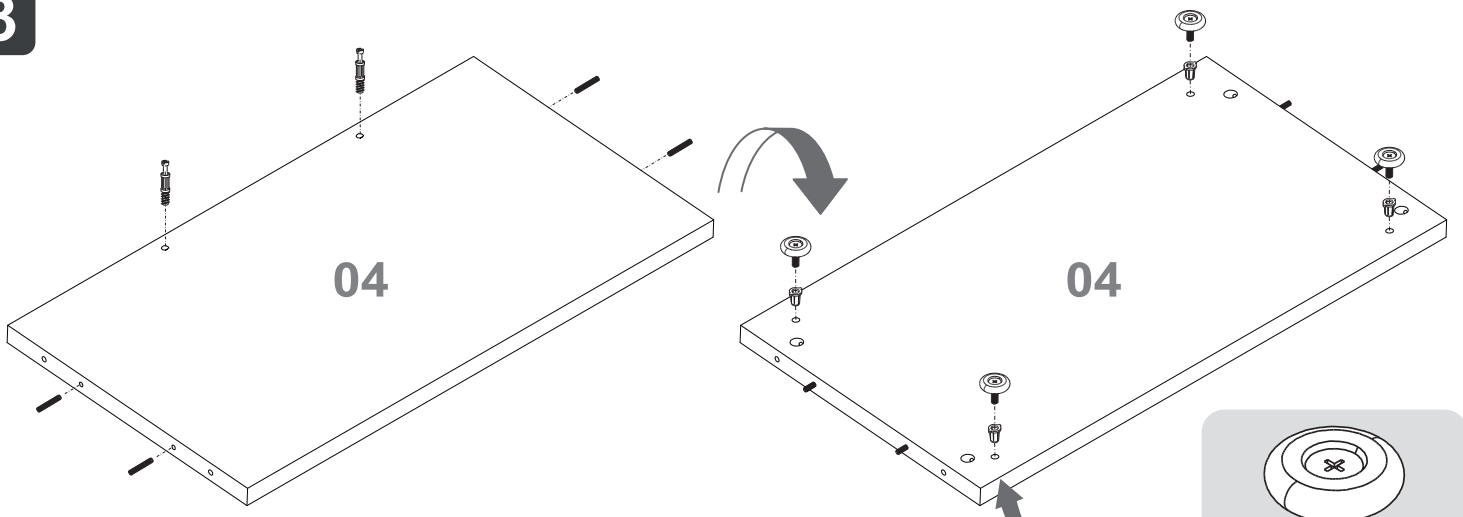

4X

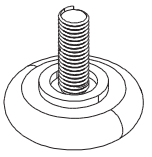

102614

4X

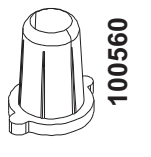

100560

4X

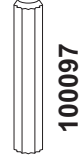

100097

2X

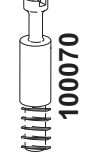

100070

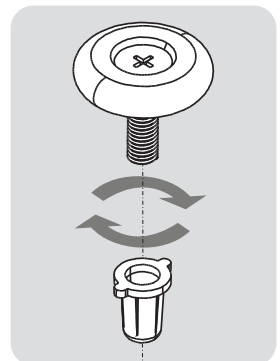

4

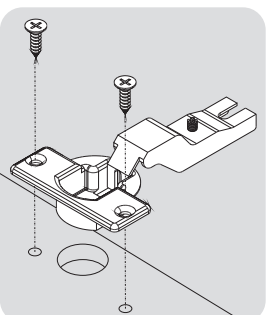
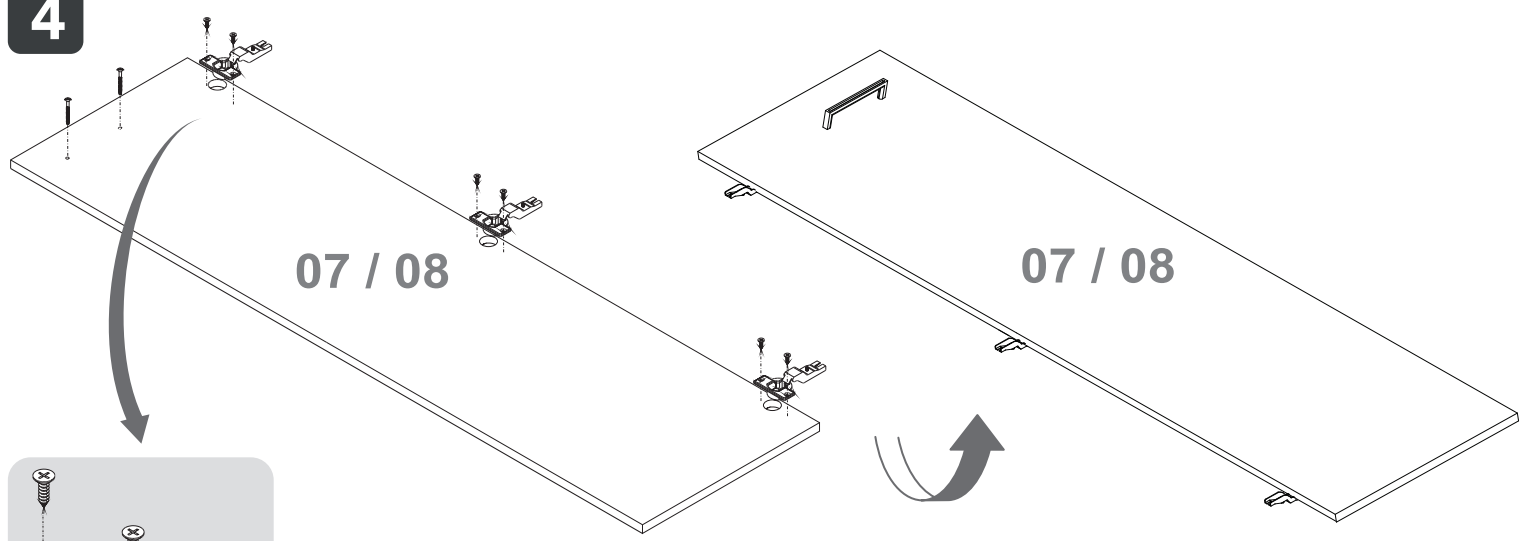

2X

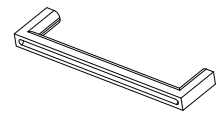

102418

4X



100503

6X

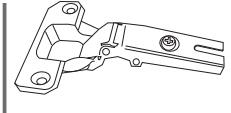

B-104173

12X



100594

5

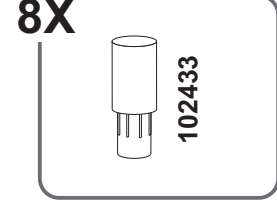
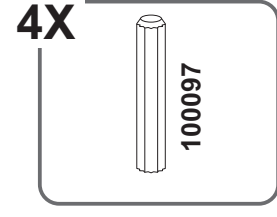
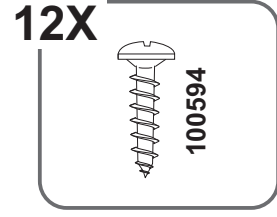
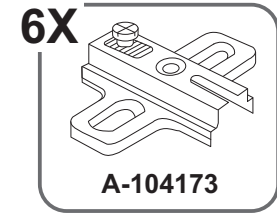
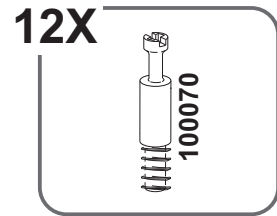
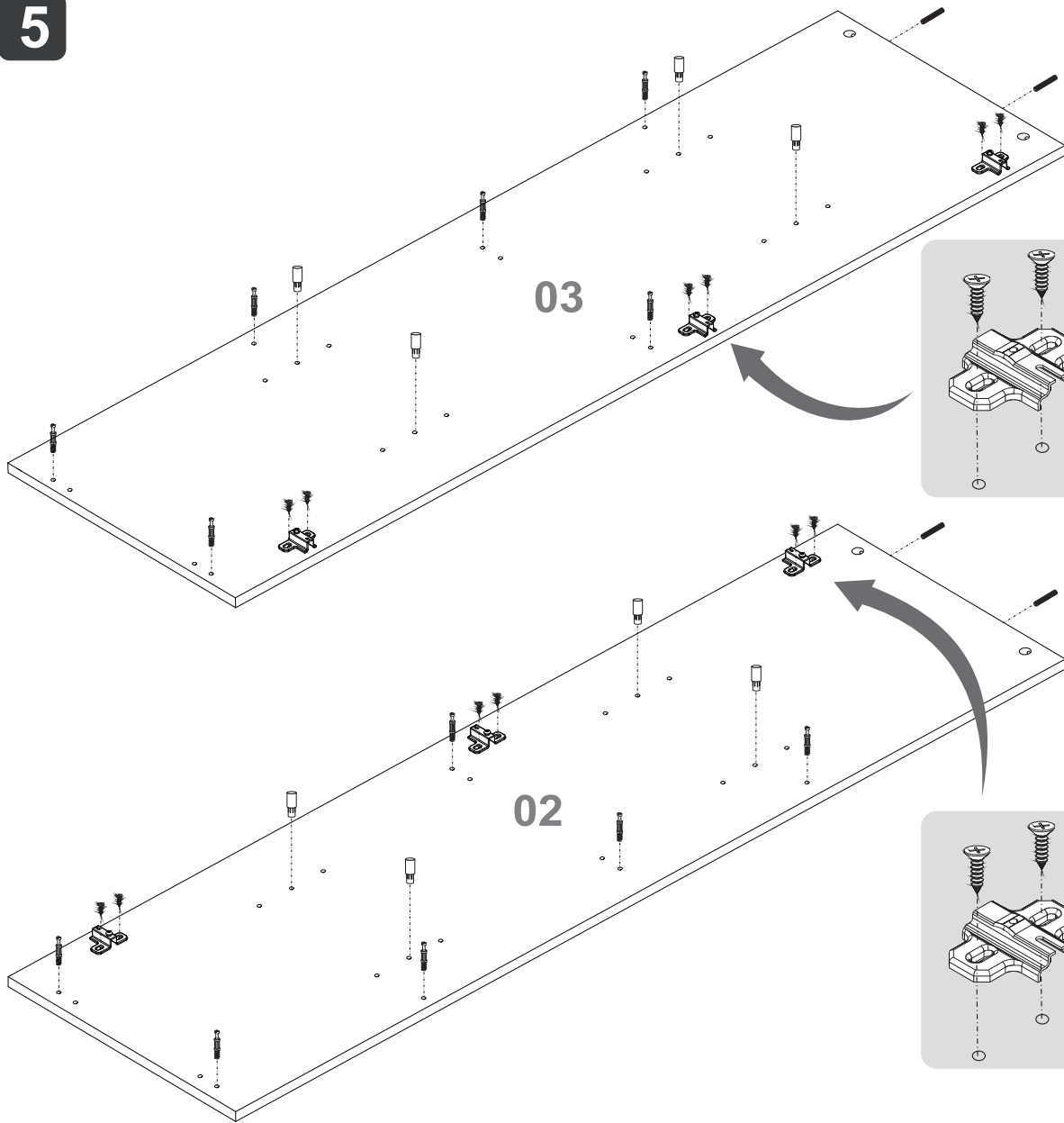

6

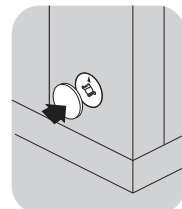
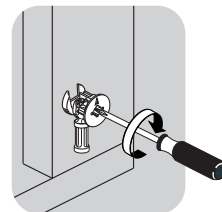
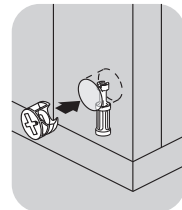
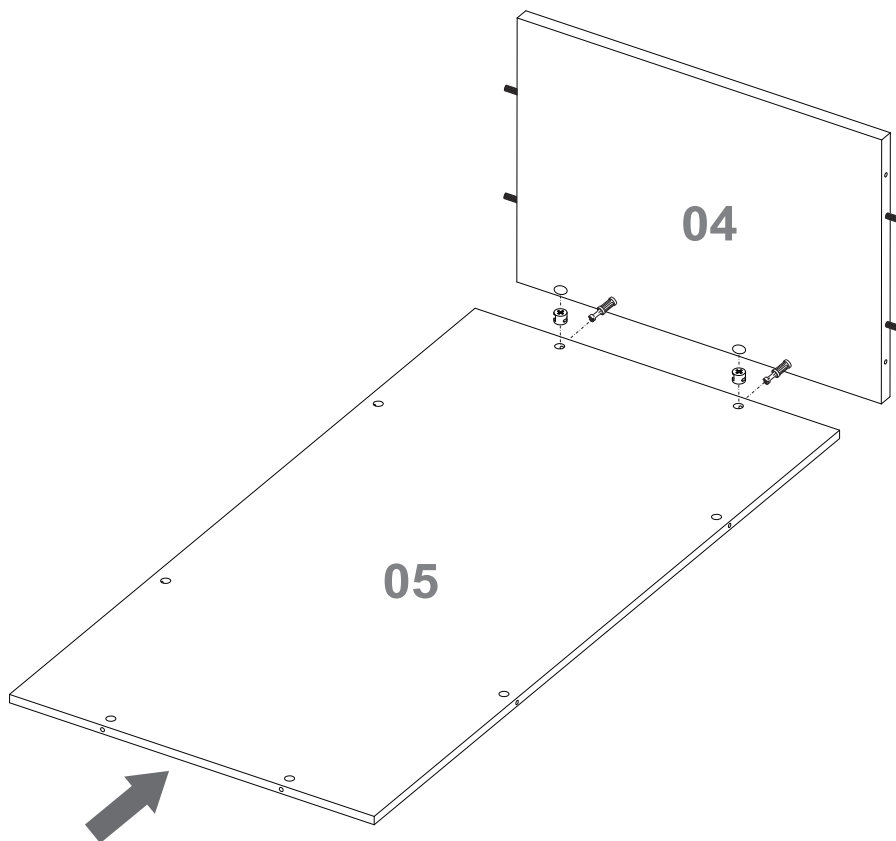
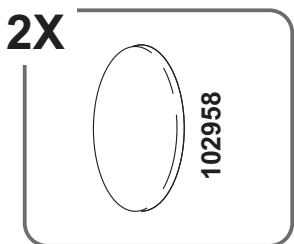
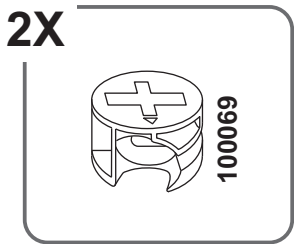

7

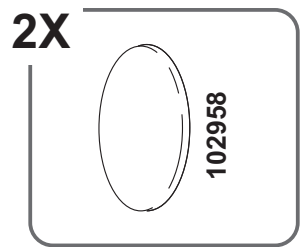
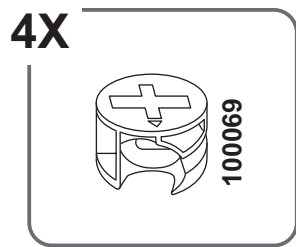
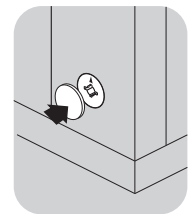
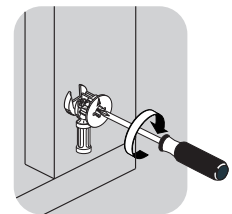
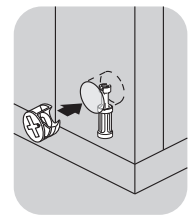
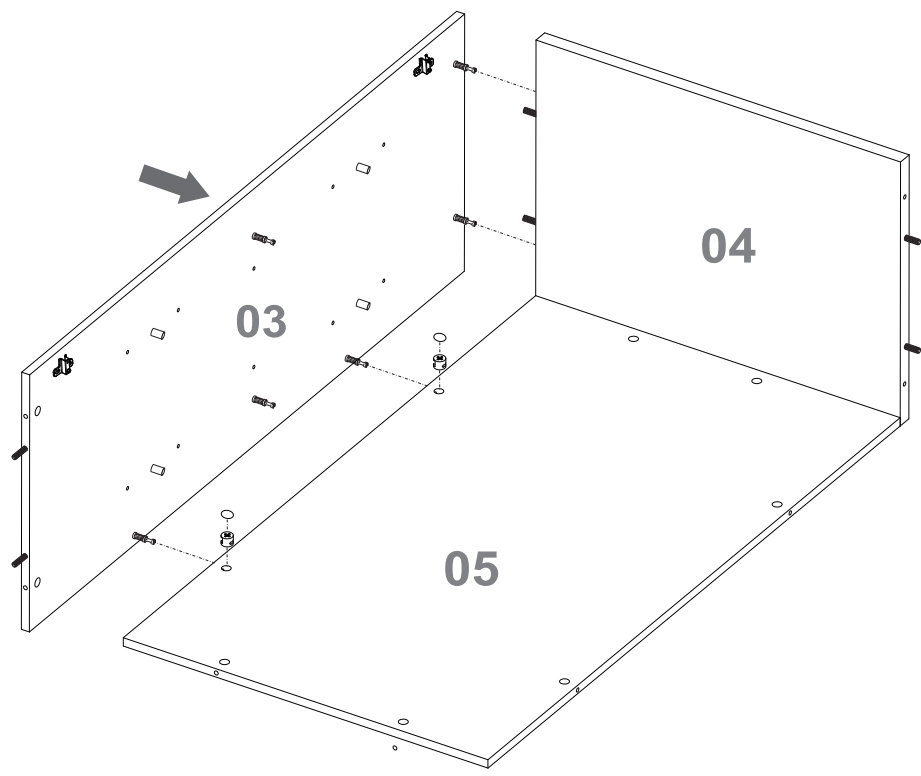

8

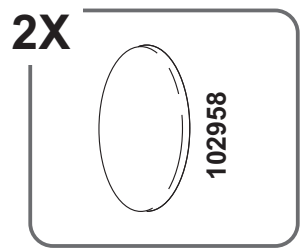
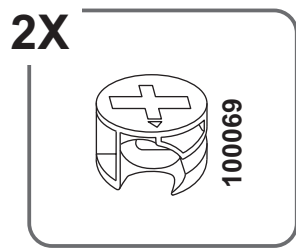
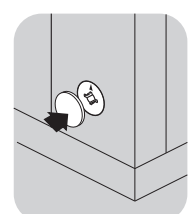
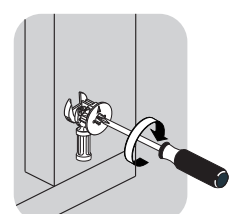
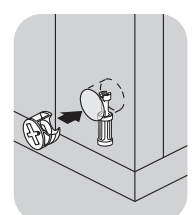
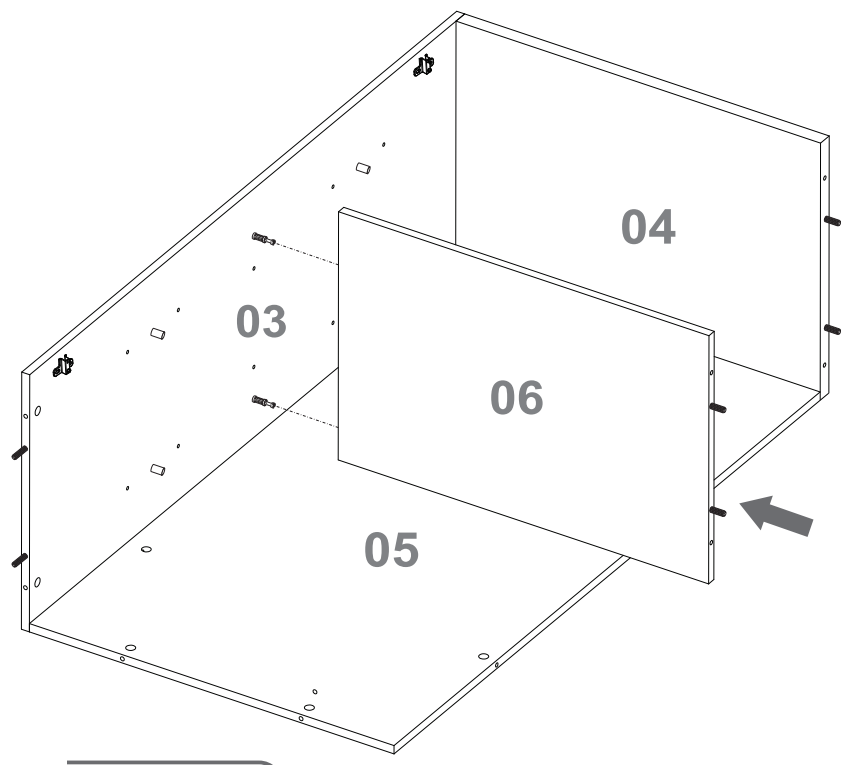

9

6X

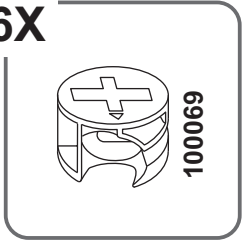

4X

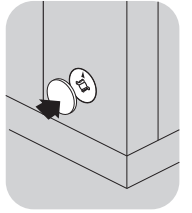
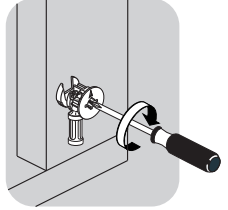
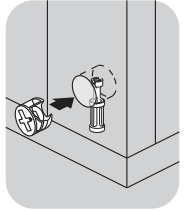
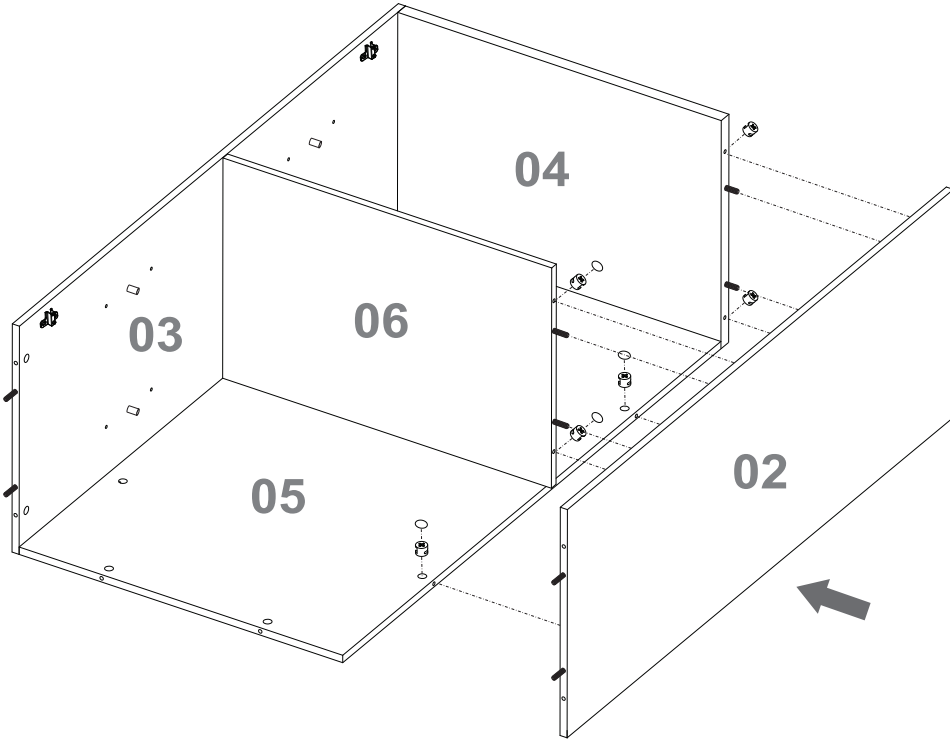
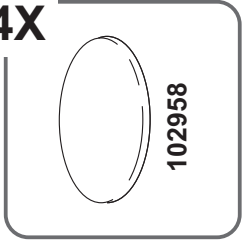

10

6X

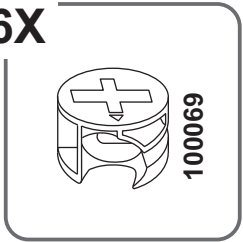

6X

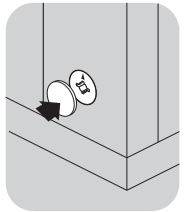
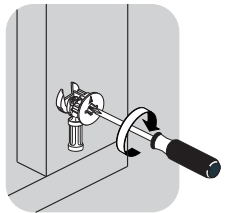
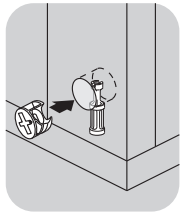
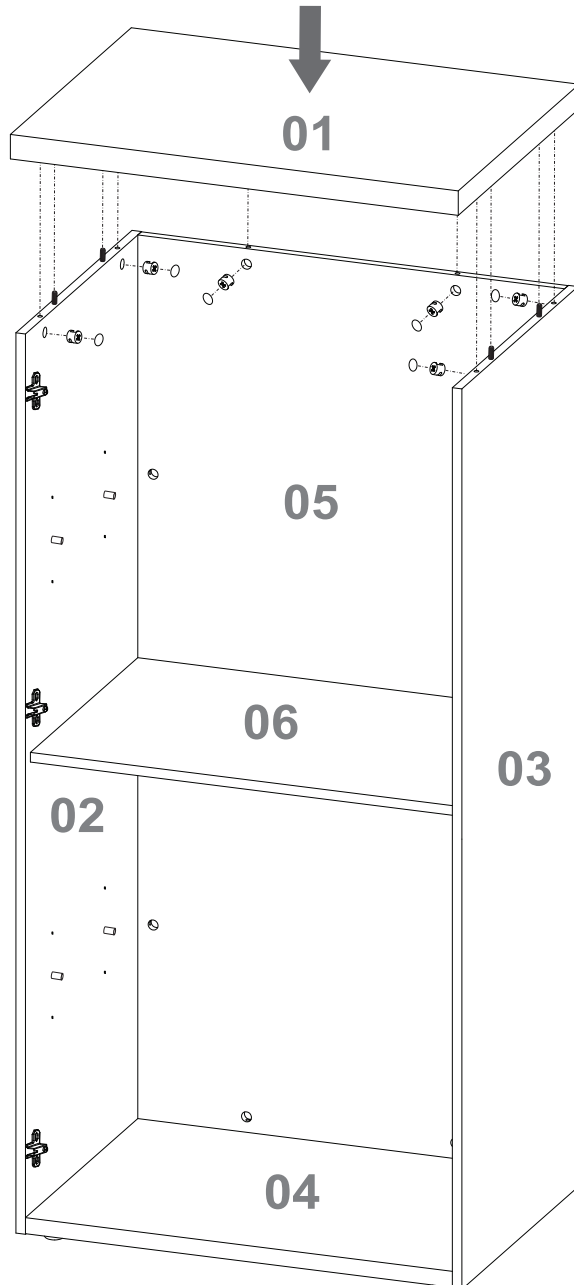
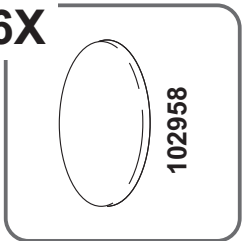

11

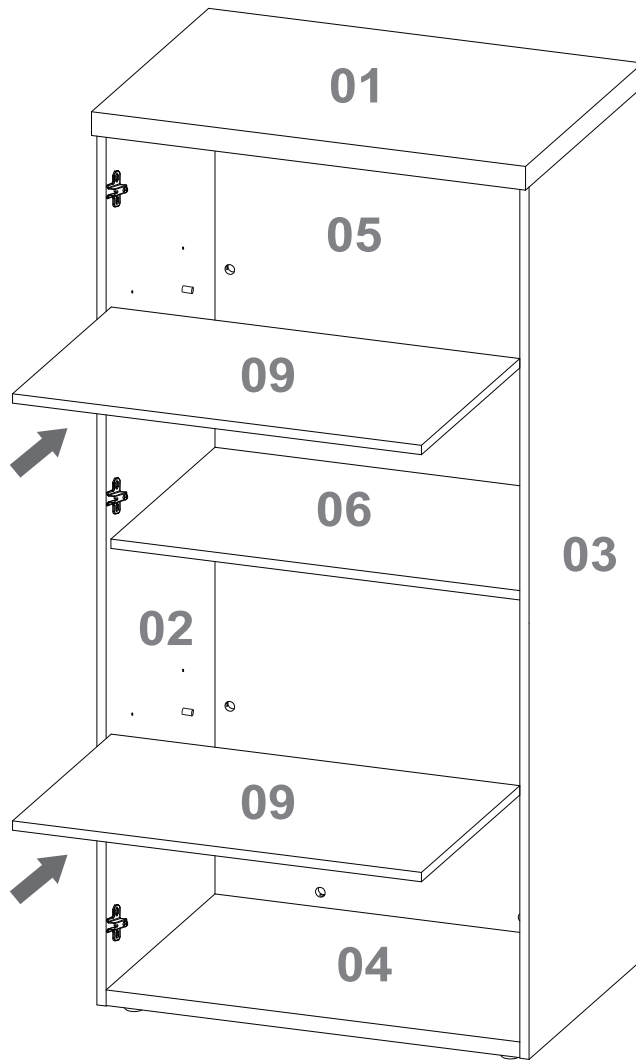

12

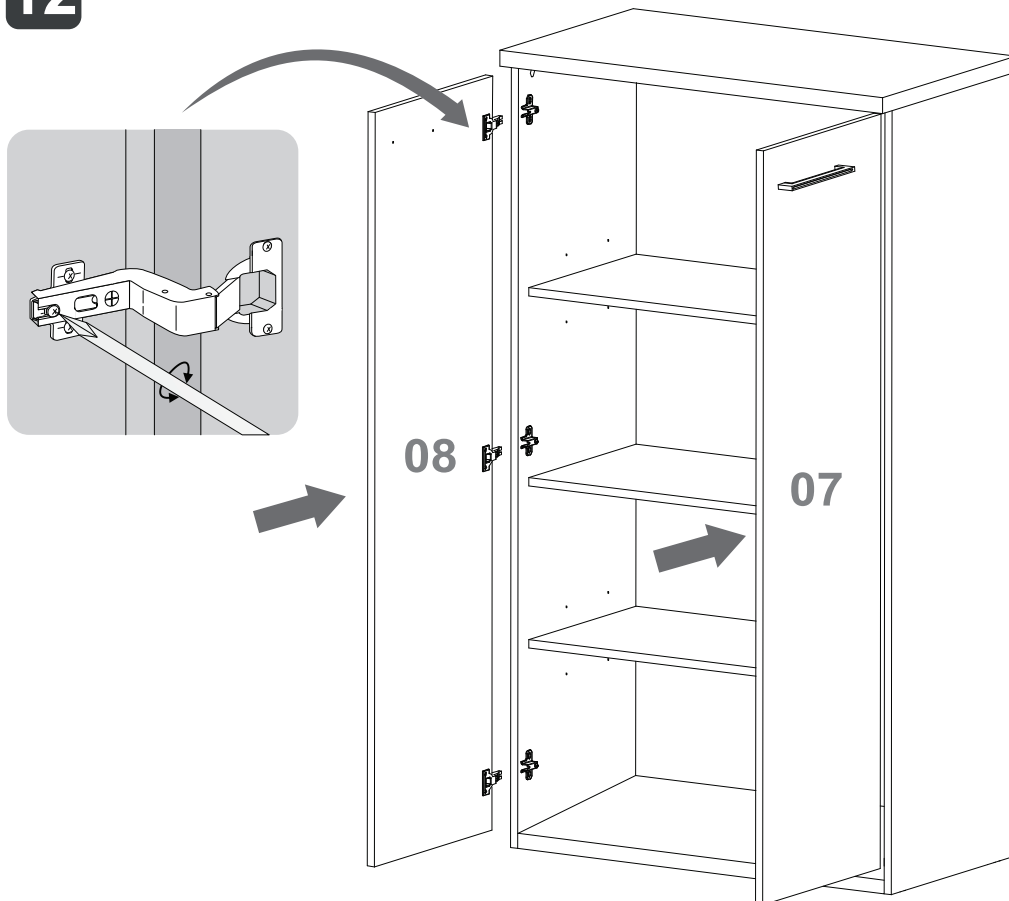

COMO AJUSTAR LAS PUERTAS
CÓMO AJUSTAR LAS PUERTAS
HOW TO ADJUST THE DOORS

